

CARPLAY/ ANDROID AUTO UNIVERSAL ADAPTER

INSTRUCTION MANUAL

| | |
|--------------------|--------------|
| Model No. | 10CP11 |
| System Ver. | 2019-04-09 |
| Manual Ver. | 1.0 |
| Date | May 07, 2019 |

CONTENT

| | |
|--|----|
| Features | 4 |
| Specifications | 5 |
| Package Components | 6 |
| Connection Diagram | 7 |
| Main Menu UI | 8 |
| Apple CarPlay | 9 |
| Android Auto | 10 |
| How To Connect Bluetooth | 11 |
| USB Storage Music & Video | 12 |
| Settings | 13 |
| Start CarPlay/Android Auto Automatically | 13 |
| Touch Calibration | 13 |
| Sounds Setting | 14 |
| Display Setting | 15 |
| Language Setting | 15 |
| Wallpaper Setting | 15 |

FEATURES

Integrated 2 in 1 module supports Apple CarPlay, Android Auto

Supports USB HD video (up to 1080P) and lossless music (APE, WAV, FLAC, MP3, WMA, etc) playback

CVBS and HDMI (480P/720P) output

Automatic enable CarPlay/Android Auto when plugging in an iPhone/Android phone

Integrate BT module for Android Auto calling audio delivering

High performance audio output and support control sound volume, EQ setting

Provide external knob controller for operation

Offer high quality microphone for phone talking & voice command

Mobile phone charging

Further software update via USB

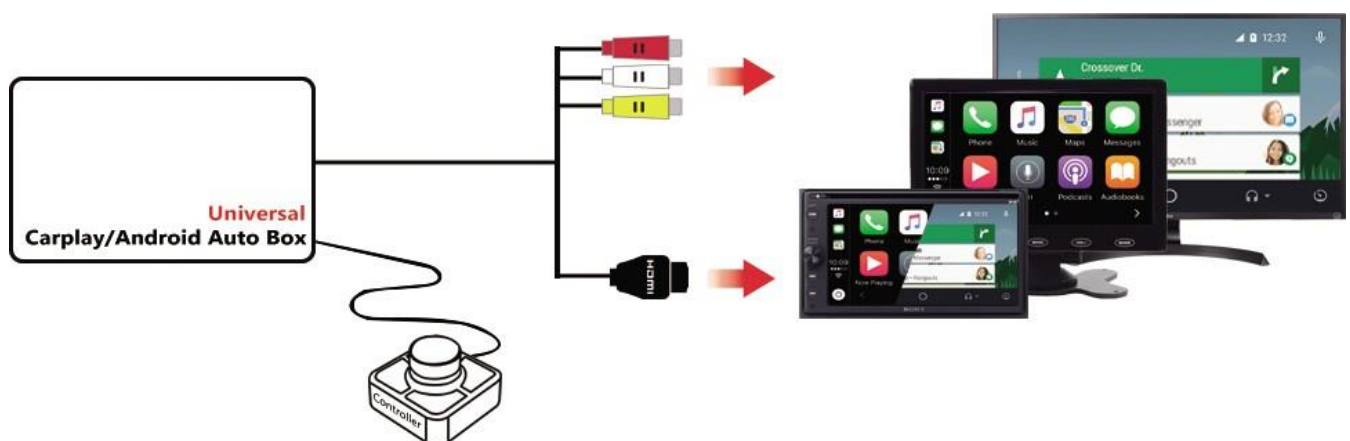

SPECIFICATIONS

| | |
|-----------------------------|---|
| Inputs | RCA*2 (1 rear camera and 1 external video in) 3.5mm AUX*1 (microphone) USB*2 |
| Outputs | RCA*3 (CVBS & audio L/R outputs) HDMI*1 |
| Output resolution | CVBS: 720*480, NTSC HDMI: 800*480 (default), 1280*720 (optional, upgrade via software) |
| Input voltage | 9-16V |
| Consumed power | 5W |
| Working temperature | -20°C~75°C |
| Main unit dimensions | 110*75*30 mm |
| Weight | 170g |



For any car/monitor with HDMI or RCA AV input.

PACKAGE COMPONENTS



Main Unit



Power Cable



Touch/Video Cable



Knob Controller



Microphone

CONNECTION DIAGRAM

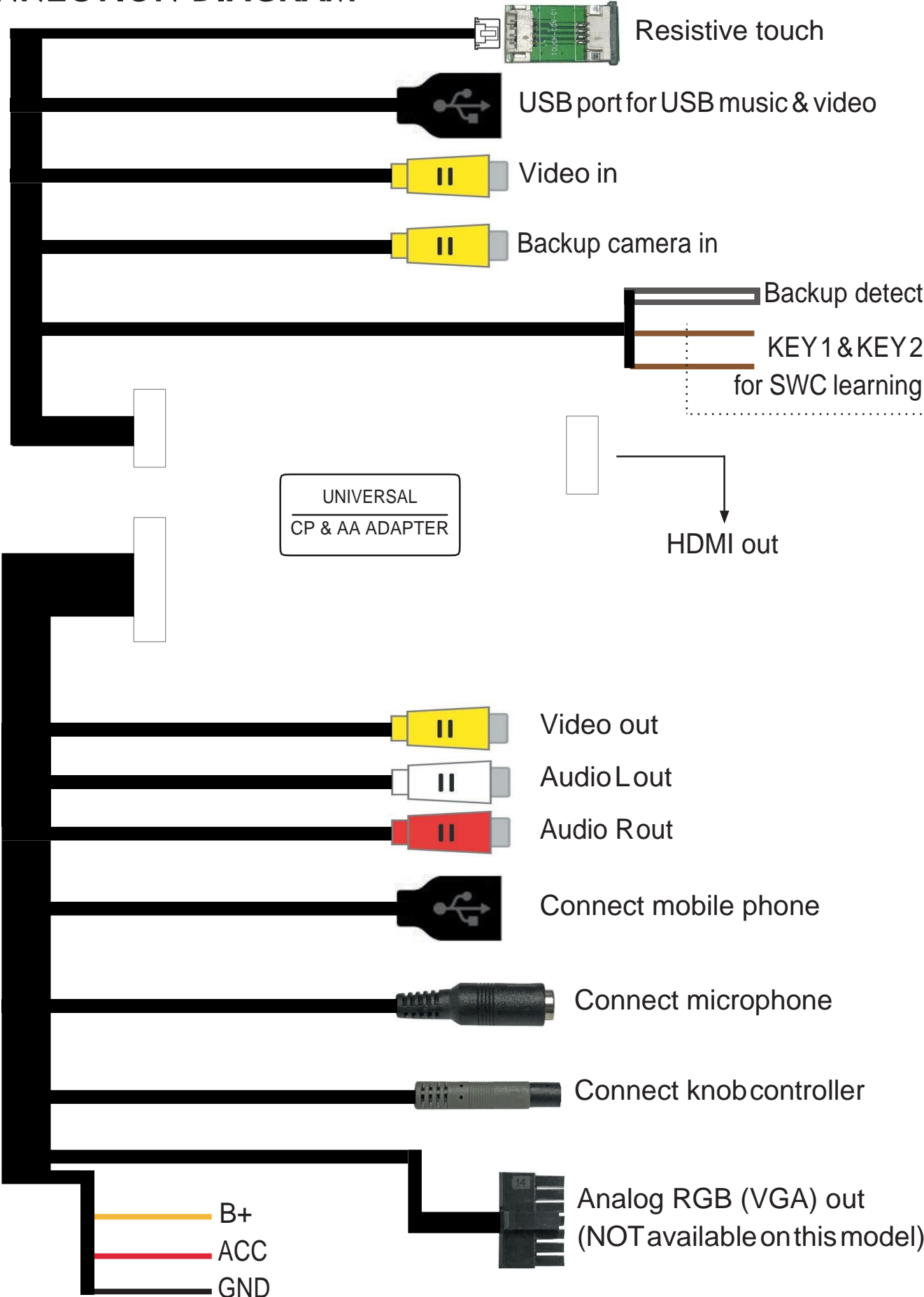

MAIN MENU UI

Statusbar

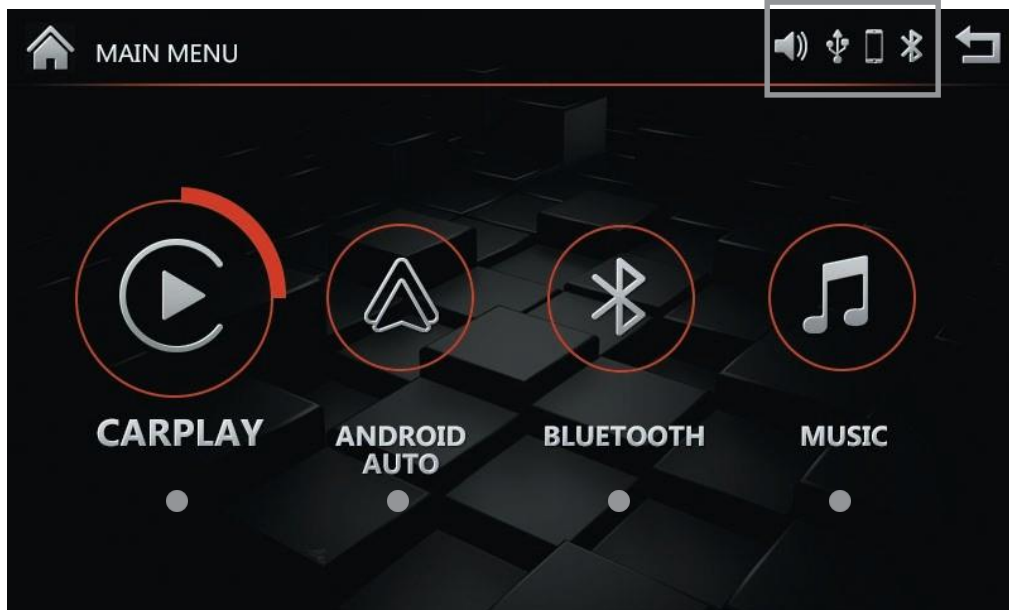

- Apple CarPlay
- Android Auto
- Bluetooth*
- USB Storage Music

* Bluetooth is designed for Android Auto calling audio delivering

Home

Back

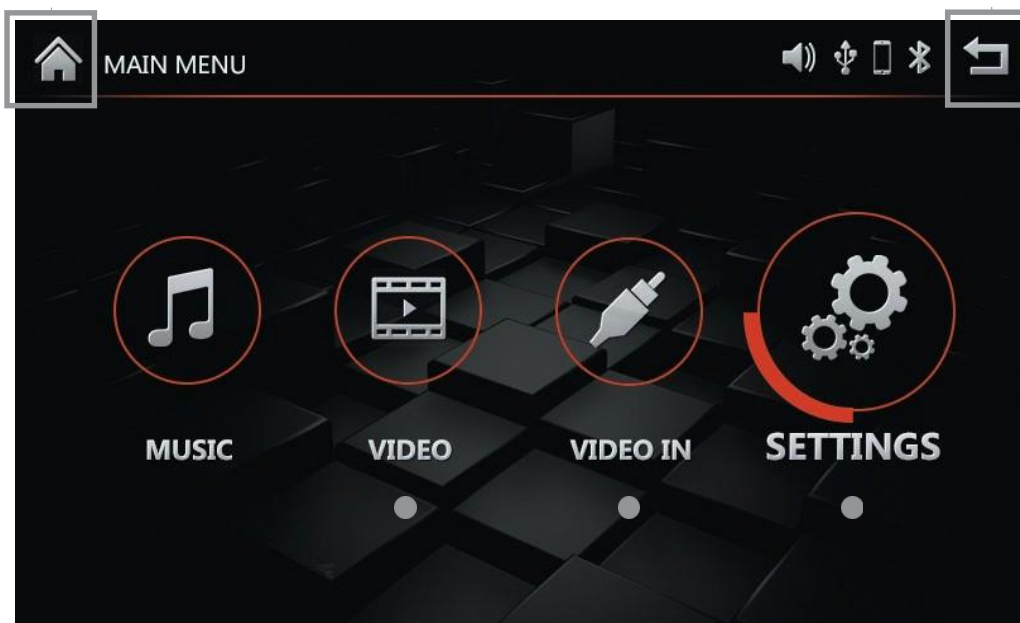

- USB Storage Video
- Additional Video in
- Settings

APPLE CARPLAY

Plug in your iPhone with USB cable, select and enter CarPlay

NOTE! Please disconnect iPhone's bluetooth before using Apple CarPlay.

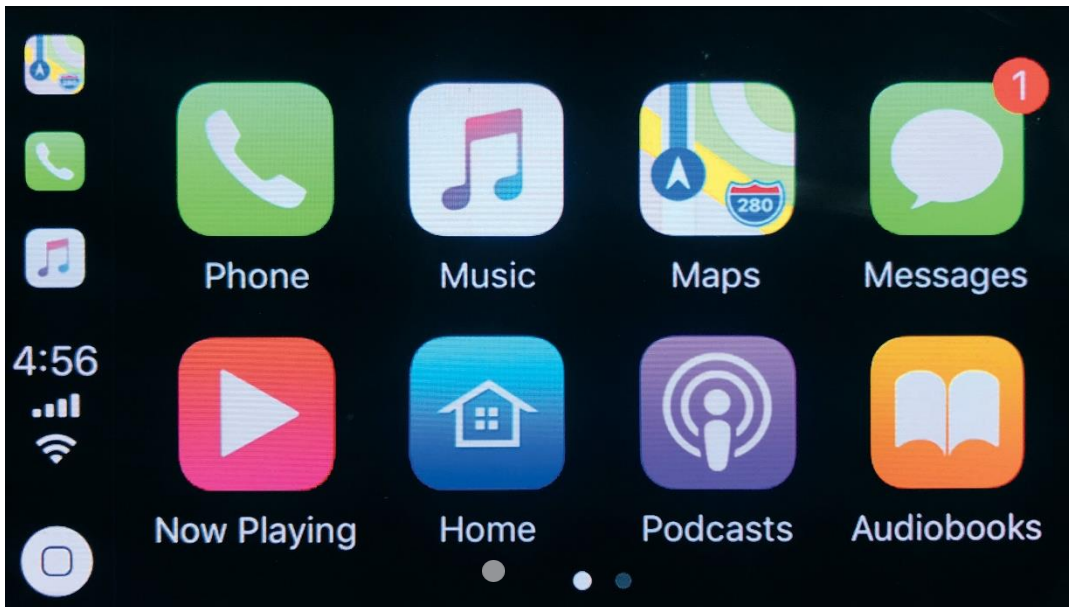

Back to main menu

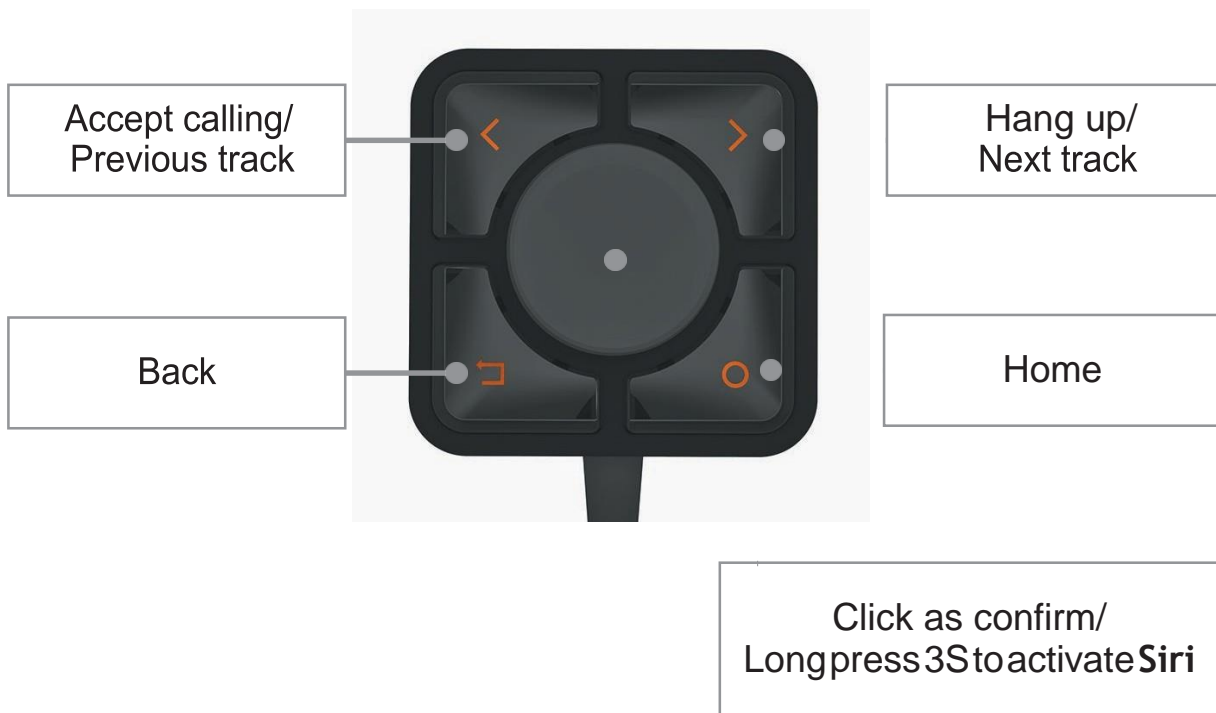

ANDROID AUTO

Plug in your Android smartphone with USB cable, select and enter Android Auto

NOTE! Make sure smartphone connect to this adapter's Bluetooth for phone call audio delivering before using Android Auto.

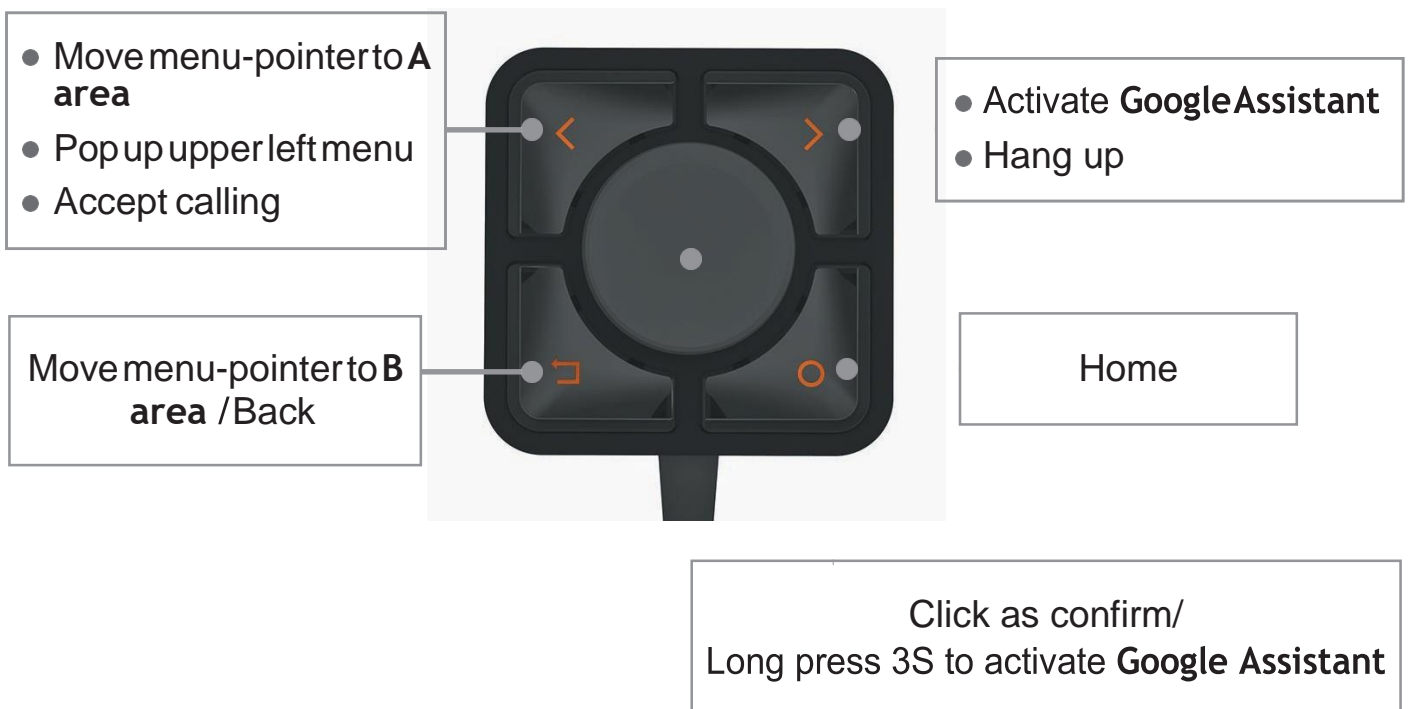
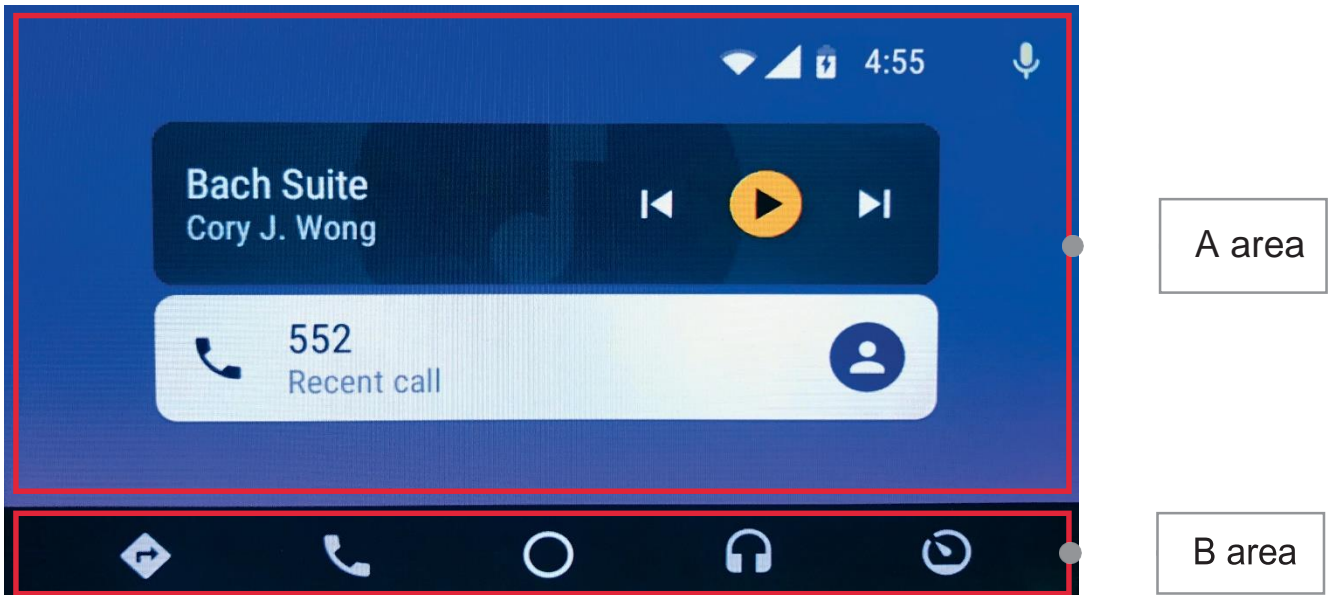

HOW TO CONNECT BLUETOOTH

Device name: Car Audio_ xxxx

Pair code: 0000

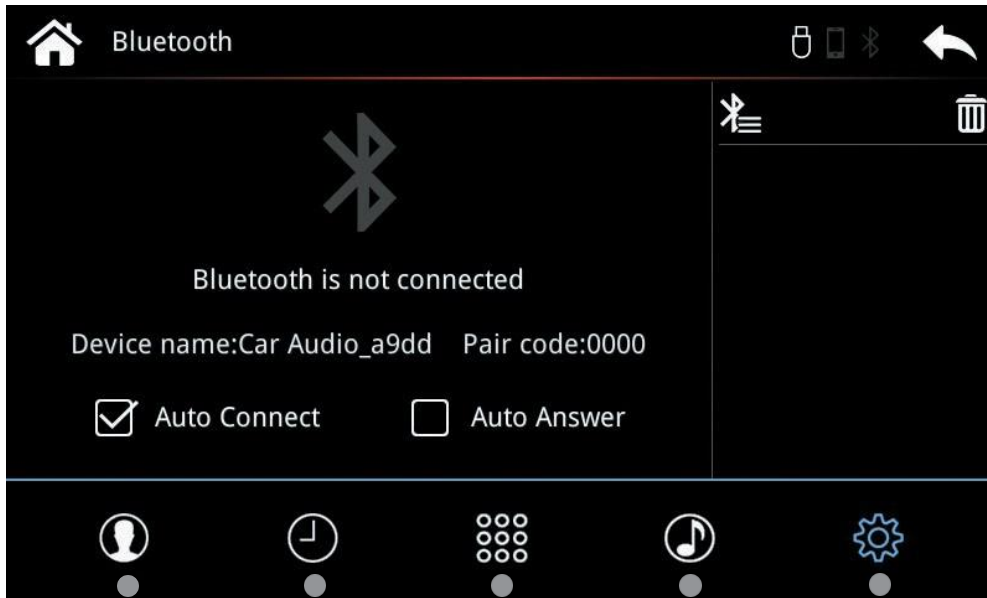

TickAutoConnect: mobile phone connect Bluetooth automatically after starting the adapter

TickAutoAnswer: Accept calling automatically

- Contacts
- Recents
- Keypad
- Music
- BTSetting

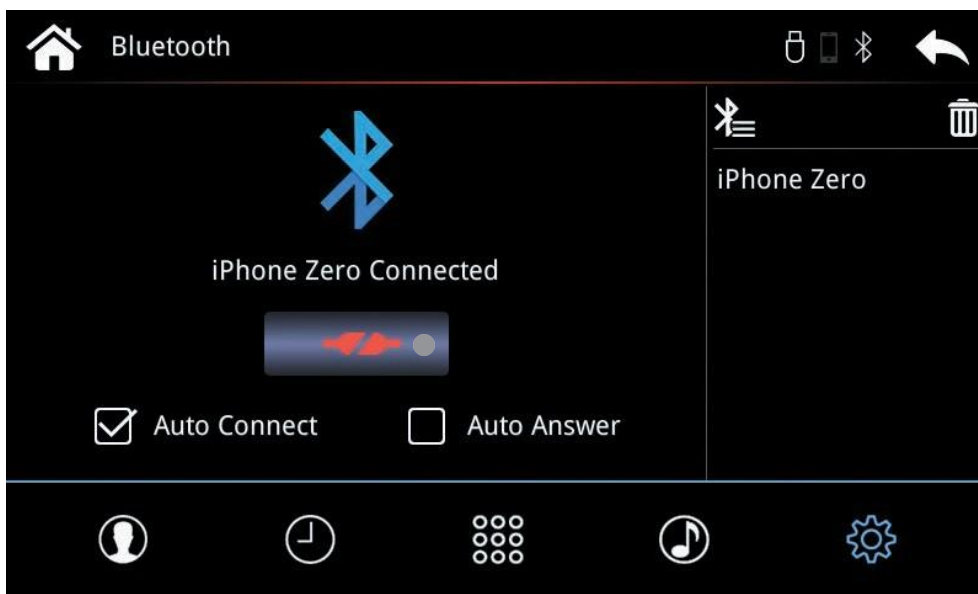

Delete paired device

Disconnect BT

NOTE! Bluetooth function is designed for Android Auto call audio delivering. It's unnecessary to connect BT when using CarPlay on iPhone.

USB STORAGE MUSIC & VIDEO

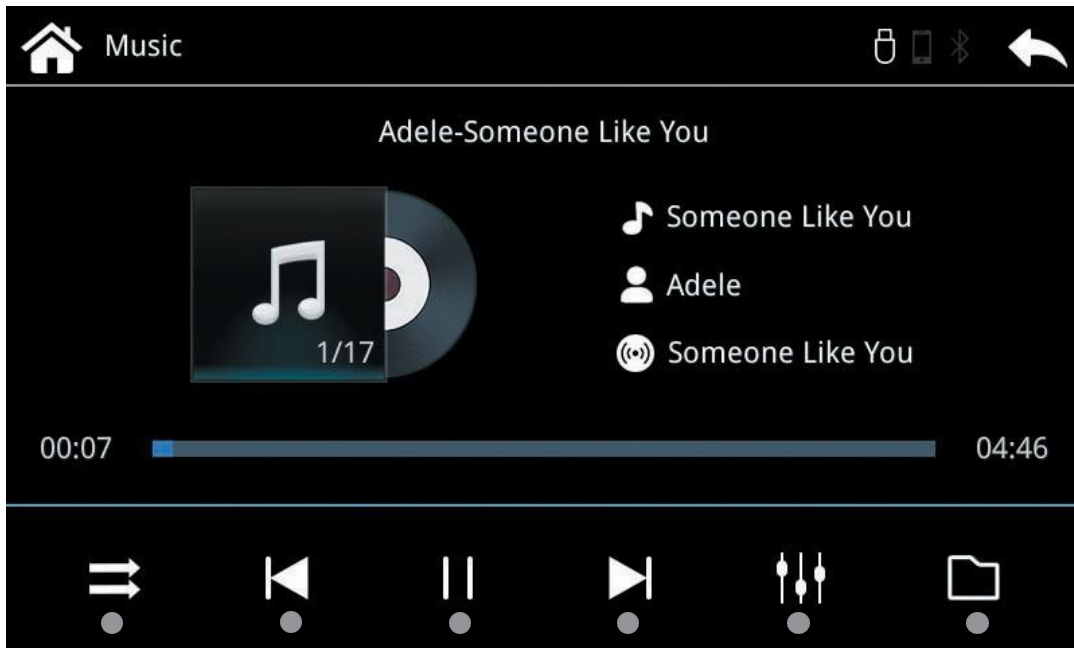

- Playmode
- Previous Pause/Play Next
- EQsetting
- Open file



SETTINGS

● START CARPLAY/ANDROID AUTO AUTOMATICALLY

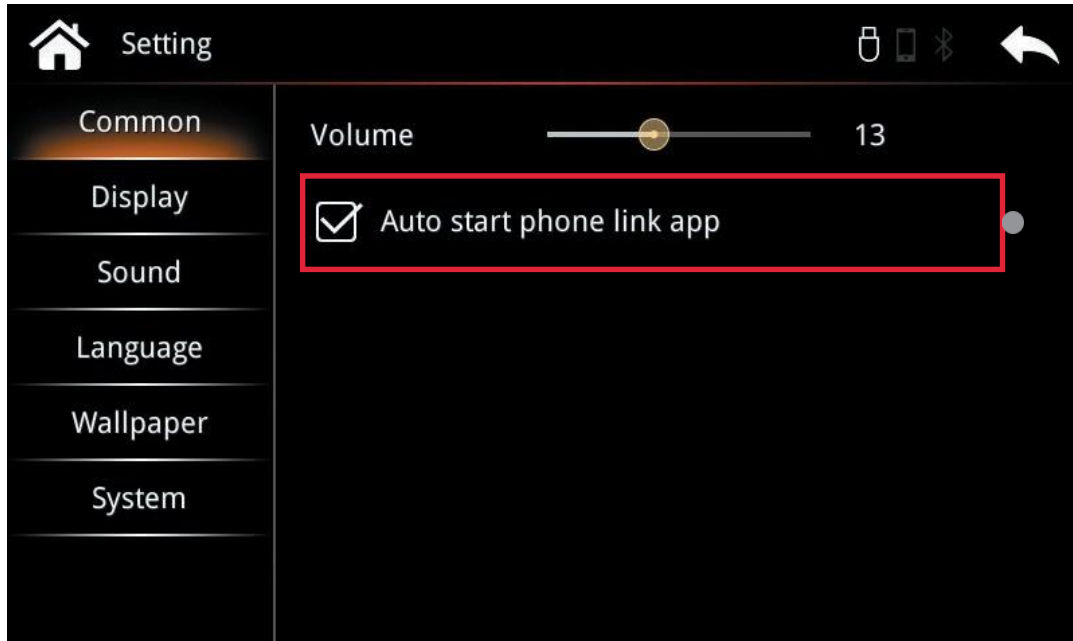

Please select "**Settings**" on main menu and tick "Auto start phone link app". Then "Carplay" or "Android Auto" will start automatically after connecting your iPhone or Android smartphone.

● TOUCH CALIBRATION

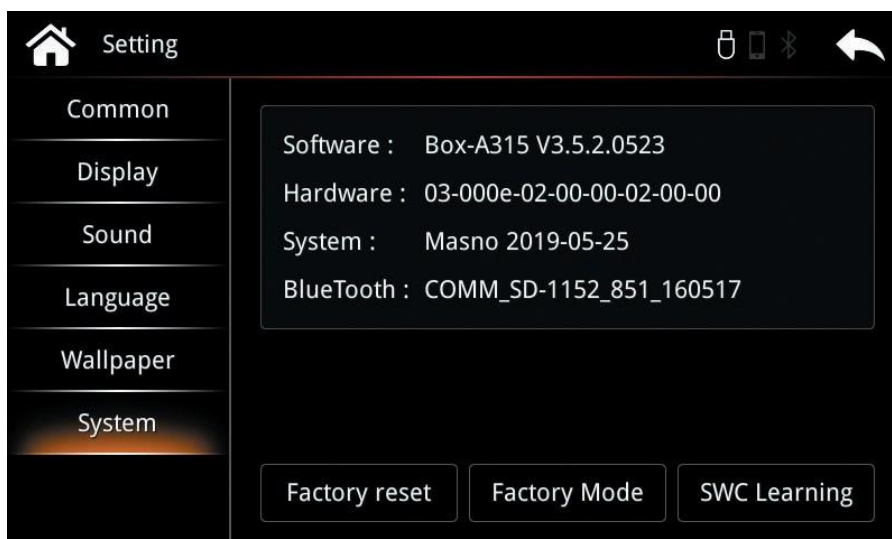

1. Select "**Settings**" on main menu -- "**System**" -- "**FactoryMode**"

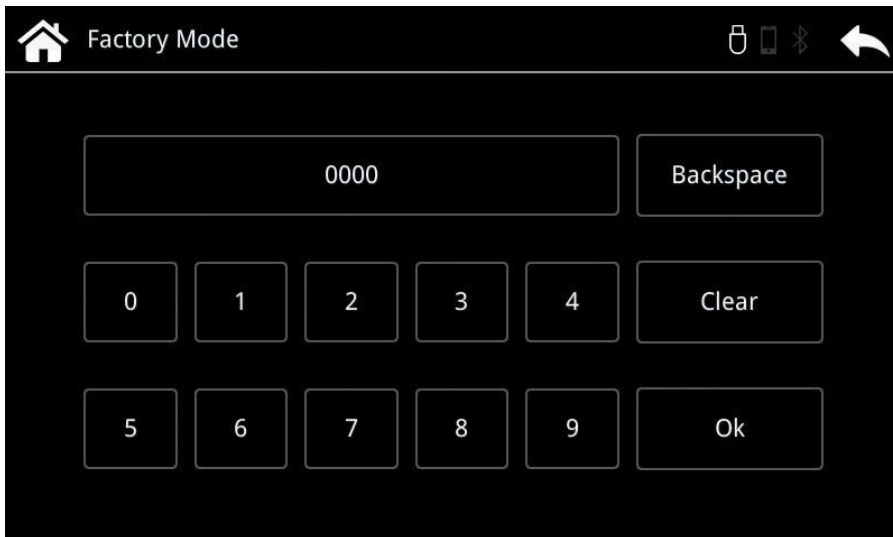

2. Type "0000" and select "OK"

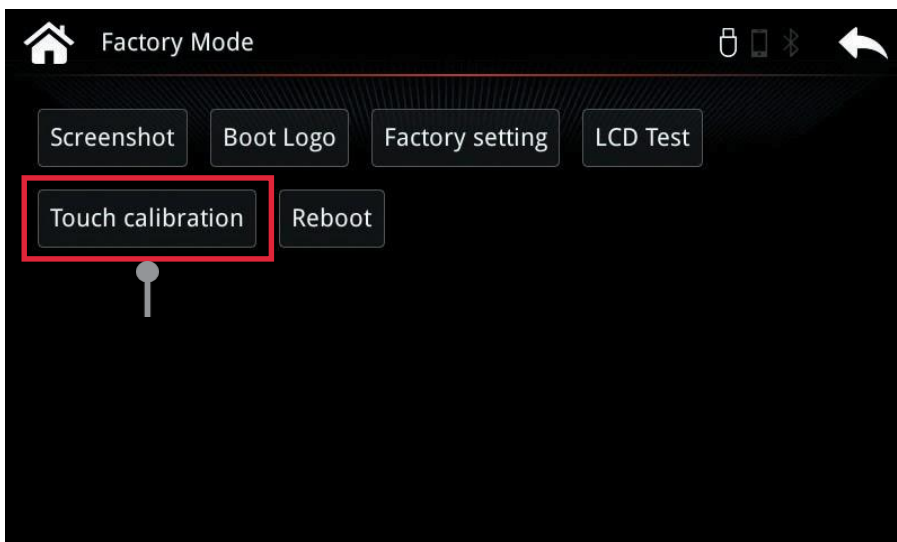

3. Select "Touch calibration" and follow the steps

● SOUNDS SETTING

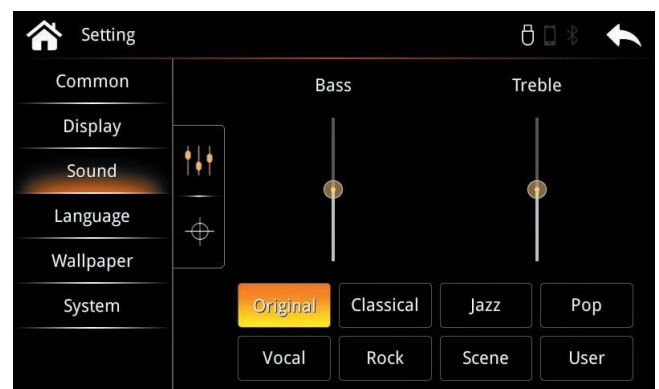
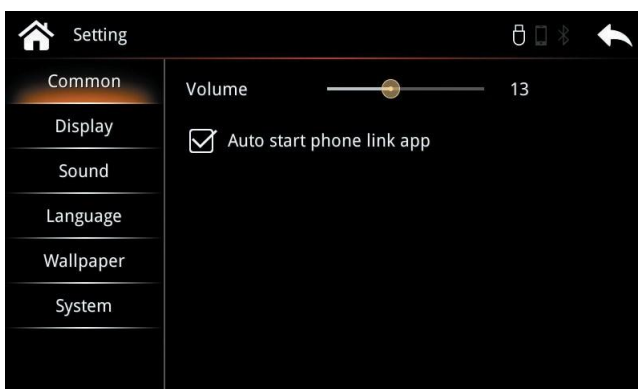

● DISPLAY SETTING

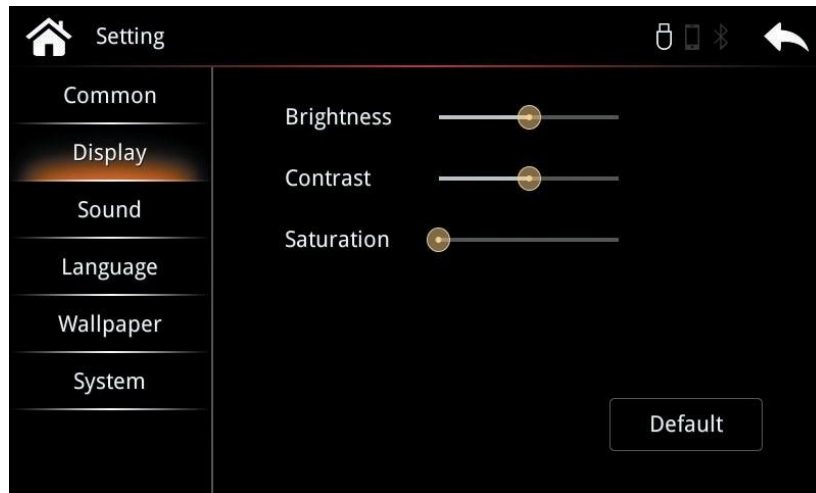

● LANGUAGE SETTING



● WALLPAPER SETTING

